

CHARGEVIEW™ 140W DESKTOP CHARGER

SKU: ST-C4CV140C-US

BEFORE FIRST USE

Optional

1

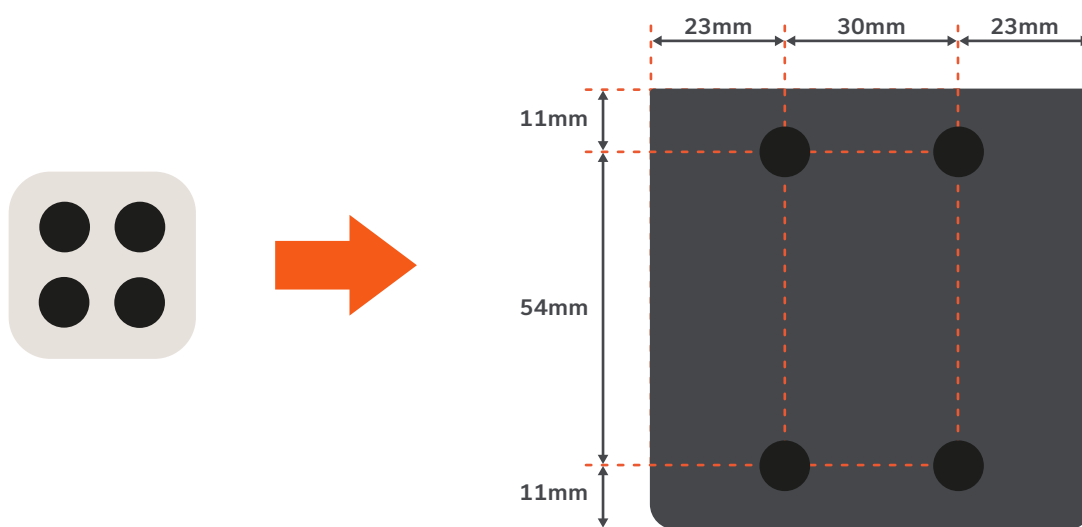

Attach the Silicone Dots

- If you plan to use the charger **without the stand**, attach the included silicone dots to keep the charger stable on flat surfaces and prevent slipping.
- If you plan to use the charger with the included stand, the dots are optional. If used, ensure they are placed correctly so they do not interfere with how the charger sits in or on the stand.
- Place the 4 silicone dots on the bottom of the charger as shown in the diagram, then press firmly to secure them.

2

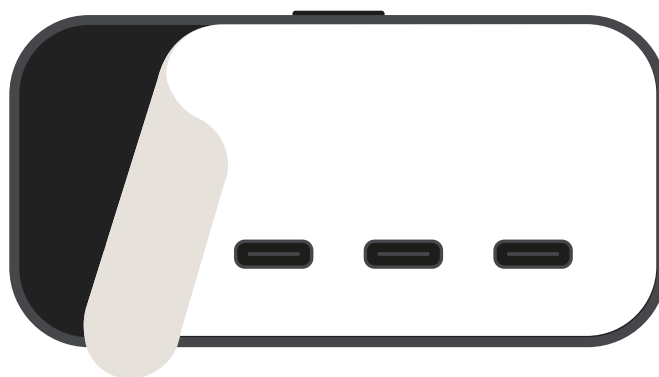

Remove the Protective Film

- Peel off the protective film from the display.

INSTALL & CONNECT

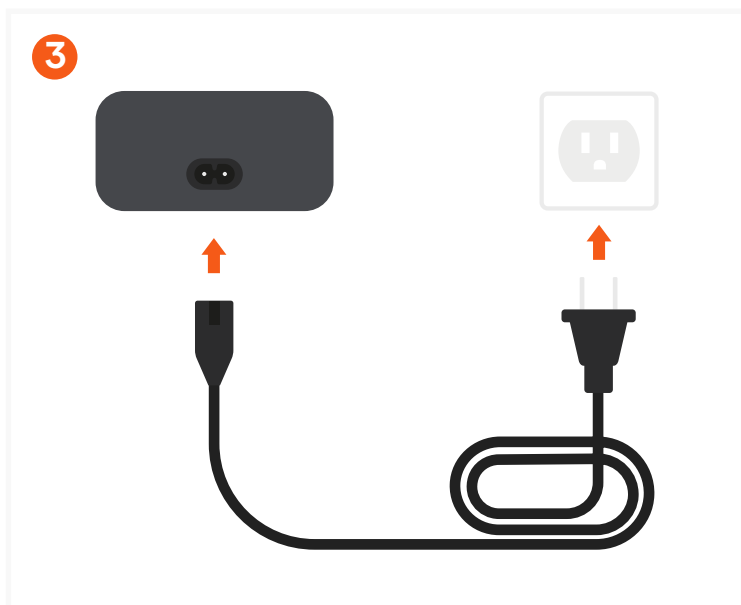

Connect the C7 Power Cord

- Connect the included C7 power cord to the power port on the rear of the charger, then plug the other end into a standard wall outlet.
- The charger accepts 100–240V input and is compatible with international outlets when used with the appropriate plug adapter.



Position the Charger (Horizontal or Vertical)

- Use the included desktop stand to position the charger horizontally (flat) or vertically (upright).
- Press and hold the power/display button for 2 seconds to switch orientation.

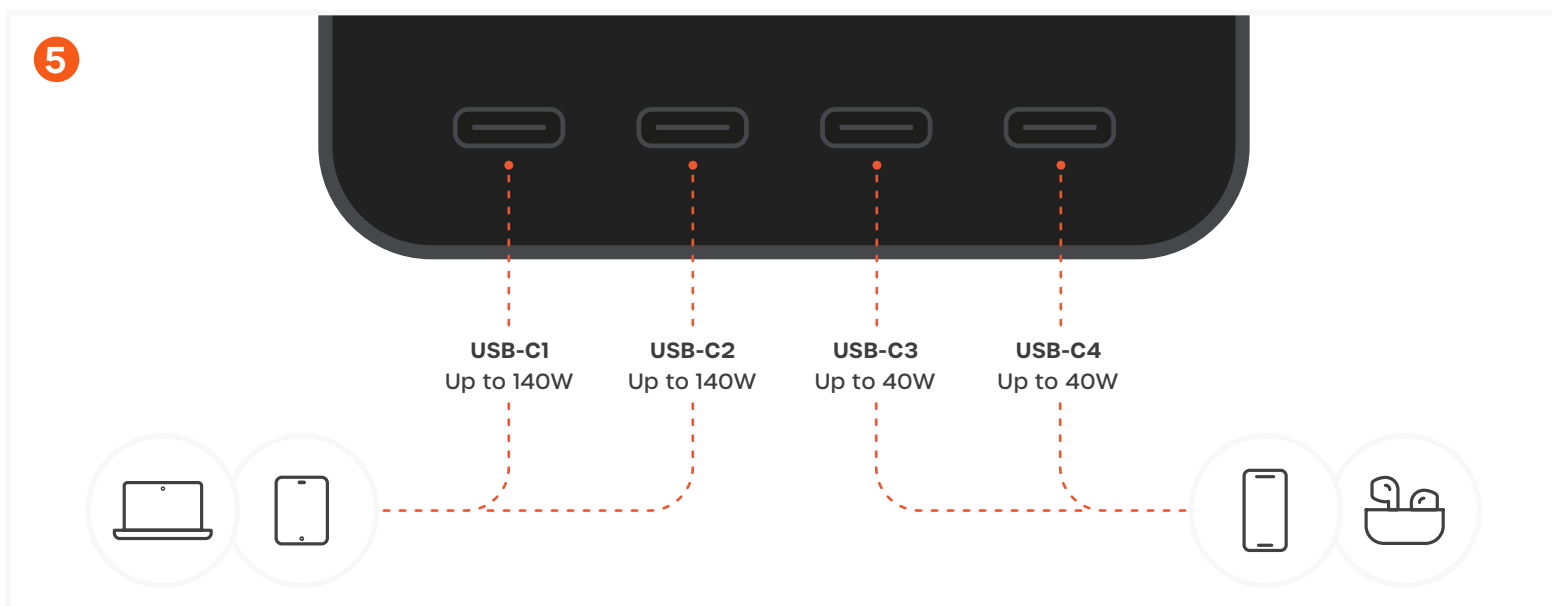

Connect Your Devices

- Connect your devices to any of the 4 USB-C ports using compatible USB-C cables.
- Port capabilities (single-port use):
 - USB-C1 (PD 3.2 AVS) – Up to 140W
 - USB-C2 (PD 3.1 PPS) – Up to 140W
 - USB-C3 (PD 3.1 PPS) – Up to 40W
 - USB-C4 (PD 3.1 PPS) – Up to 40W
- For the fastest single-device charging, use USB-C1 or USB-C2.
- Power output adjusts automatically when multiple devices are connected.

MONITOR CHARGING & TEMPERATURE

6



Monitor Charging via the Digital Display

The digital display provides real-time charging information and system status:

- When powered on, the Satechi logo appears for 3 seconds.
- Press the power button to cycle through display screens (e.g., total output and per-port views).
- The display shows real-time wattage and charging status for each active port.
- Each port indicator turns green when in use.
- The AVS indicator on USB-C1 turns green for 5 seconds when fast charging is active on compatible devices (e.g., iPhone 17 Pro / Pro Max).
- After 1 minute of inactivity, the screen turns off and enters sleep mode.
- The display wakes when a device is connected or the power button is pressed.

7

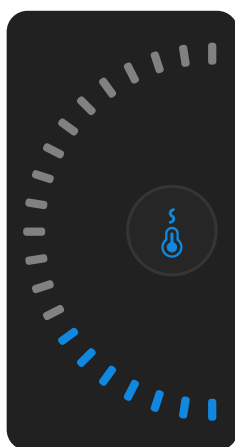

Excellent

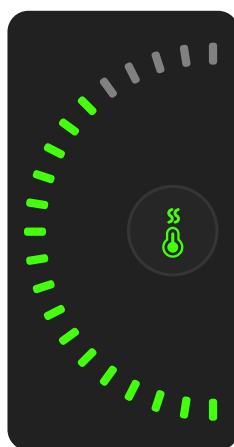

Optimized



Cooling

Read the Temperature Monitoring Indicator

The temperature monitoring indicator reflects the charger's current thermal state:

- Blue – Excellent
- Green – Optimized
- Orange – Cooling
- For optimal performance, ensure adequate airflow around the charger and avoid placing it in enclosed or confined spaces.

SPECIFICATIONS

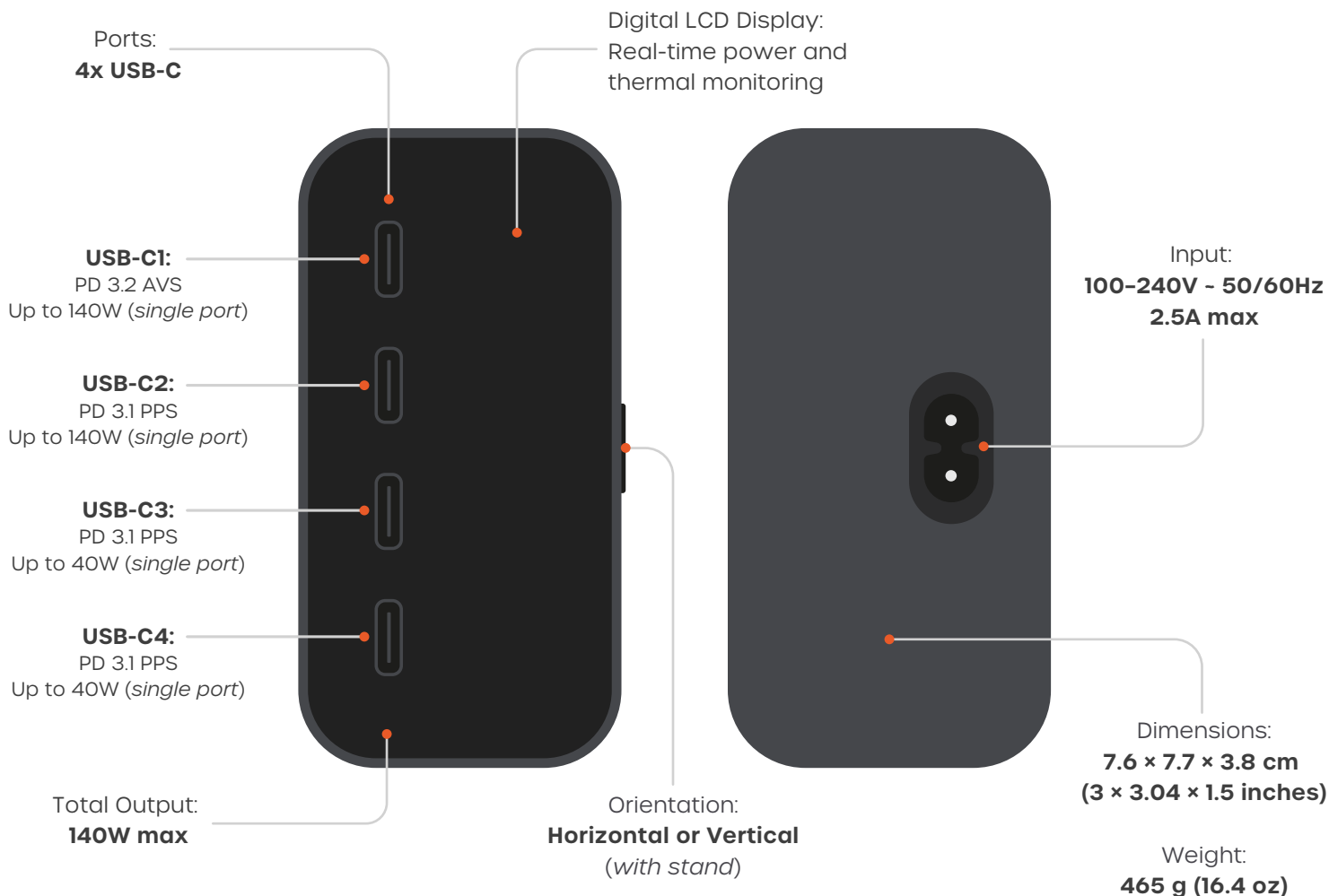

INCLUDES:



Stand



C7 power cord



4x silicone dots

CERTIFICATIONS & SAFETY

FCC Class B



CE Certified



ICES(B)/NMB(B)



Intertek



WEEE

